

## PMC50X Concrete Floor Box

The PMC50 Floor Box is the ideal solution for most concrete floor applications that require power and low voltage connections in a mid size floor box.

The concrete floor box accepts a wide variety of power, data and A/V connectors such as duplex receptacles, decorator style inserts, keystone style jacks as well as our exclusive FIT-IN system, which accepts up to 12 FBS modules in one box.

The lid can be rotated with no tools for easy outgoing cables orientation. Two cable guards protect cables and reduce risk of damage to all incoming and outgoing cables. A recessed space (7/16 In.) allows to insert a piece of floor covering material providing a smooth, seamless look. The cover can be adjusted and levelled after concrete pour.

PMC50 floor boxes are suitable for use in concrete floors interior dry locations only where the accumulation of scrub water is unlikely to occur.



PMC50B Concrete Floor box

### Features



PMC50 Floor box

- 16 GA Galvanized steel housing - Provides added strength and protects against corrosion.
- 18 Concentric knockouts for 1/2" & 3/4" conduits.
- Flexible design - Allows the user to rotate the modules with box in-situ.
- Removable barriers separate the two compartments.
- Ultra Low box - Easy installation in low profile floors (3 5/16" depth)
- "New Work" and "Old Work" options available.
- Quick and easy installation
- Built-in tunnel allows to feed opposed compartments.
- Manufactured in compliance with UL514A and 514C Standards.
- Made in U.S.A.

	Length	Width	Height
Floor Box	10 3/16" (259 mm)	8" (201 mm)	3 5/16" (84 mm)
Cover	11 1/8" (283 mm)	8 7/8" (225 mm)	1/8" (3 mm)



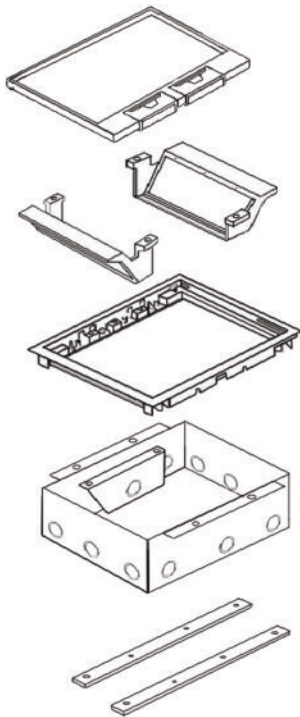

Floor Box cover w/ recessed space for the floor covering material. (7/16" max.) (Supplied)

Mounting chassis for faceplates. Allows to mount faceplates and barriers. (2 Units per kit - Supplied)

Flange / trim hides edges of hard surface flooring and prevents carpet from fraying. (Supplied)

16GA Galvanized steel box. (Supplied)

Levelling bars (Supplied assembled)

### Covers



**Kit# PMC50B**  
Includes box, black cover & temporary cover.



**Kit# PMC50G**  
Includes box, gray cover & temporary cover.



**Kit# PMC50A**  
Includes box, almond cover & temporary cover.

### Cover Features











- Low profile beveled flange - Provides a seamless, smooth finish.
- Material - Polyamide . UL94 V2 flammability
- Removable and reversible lid - Can be easily rotated with no tools required.
- 7/16" (12 mm) Rectangular recess - Permits the installation of different floor material and thicknesses.
- Reinforcement plate - 11 GA Provides added strength and adds load capacity.
- Cable guards with rubber foam and handle - Can be tilted when in use or closed when not used.
- Locking Screws - Quick installation. No visible screws when closed
- Subtle flange - Hides edges of hard surface flooring and prevents the carpet from fraying.

Faceplates & connectivity options: (See page 22)

**FBS Faceplates**  
( For use with PMC47X / PMC50X / WFB244X )







**Connectivity Options**

- Faceplates are available in three different dimensions identified as (1/4) "One quarter" type, (3/4) "Three quarters" and (4/4) "Four quarters" types.
- Each side of the box is filled with (4/4) "Four quarters", combining (Qty:1) 1/4 Type and (Qty:1) 3/4 type faceplates.
- Select the appropriate faceplates to complete 4/4 "Four quarters". (ie: One (1/4) + One (3/4)= 4/4 fills side A)

Image	Part #	Image	Part #
	<b>13603 - Blank</b> 1/4 Type Faceplate - Combine with 3/4 Faceplate to fill one side of the box.		<b>13623 - Two Keystone Ports</b> 1/4 Type Faceplate - Combine with 3/4 Faceplate to fill one side of the box.
	<b>13634 - Two Systimax (M Series) Requires Systimax mounting collar.</b> Note: Combine with 3/4 faceplates to fill one side of the box.		<b>13612 - Decorator Style</b> 3/4 Type Faceplate - Combine with 1/4 Faceplate to fill one side of the box.
	<b>13601 - Duplex Receptacle</b> 3/4 Type Faceplate - Combine with 1/4 Faceplate to fill one side of the box.		<b>13600 - Blank</b> 3/4 Type Faceplate - Combine with 1/4 Faceplate to fill one side of the box.
	<b>14606 - Three XLR Type Cut Outs</b> 3/4 Type Faceplate - Combine with 1/4 Faceplate to fill one side of the box.		<b>44633 - Duplex Type + 4 Keystone ports</b> 4/4 Type Faceplate - Fills one side of the box. <b>Barrier supplied.</b>
	<b>44644 - Duplex + 4 Systimax M Series jacks.</b> Req. Systimax M collar. 4/4 Type Faceplate - Fills one side of the box. Barrier supplied.		<b>44607 - Fit-In Yoke</b> 4/4 Type Faceplate - Fills one side of the box. Barrier supplied. (*)

**Fit-In Modular System**

The Fit-In Modular System optimizes the floor box capacity and allows the user to configure and install up to 12 modular inserts for power and/or low voltage such as VGA, HDMI and most keystone style jacks. Select one Fit-In yoke part #44607 and six modules of your choice for each side of the box.

							
<b>Part #</b>	<b>FBS61</b>	<b>FBS62</b>	<b>FBS63</b>	<b>FBS64</b>	<b>FBS65</b>	<b>FBS66</b>	<b>FBS67</b>
<b>Description</b>	<b>15A - 125V Receptacle</b>	<b>Double port for Systimax (M Series) jacks</b>	<b>Single port for Systimax (M Series) jacks</b>	<b>Single Port for Standard Keystone Style jacks</b>	<b>Double port for Standard Keystone Style jacks</b>	<b>Blank Module</b>	<b>Double port for Panduit (Minicom) jacks</b>

Part numbers FBS62, FBS63 and FBS67 provide flush finish between the jack and the module.  
Part number FBS65 accepts RJ keystone jacks High Density or slim profile.

(\*) **Barrier -Part # BDP50-** is supplied when power and low voltage are combined in the same side of the box.